



## tM-7530

Intelligent tiny RS-232 to CAN Converter

### ■ Features

- Fully compatible with ISO 11898-2 standard
- Support various CAN baud rate Max. 1M bps
- Support user-defined CAN baud rate
- Support various RS-232 baud rate Max. 230400 bps
- External option 120 Ω terminal resistor
- Power, data flow and error indicator for CAN and RS-232
- Support various communication mode
- Software buffer on CAN bus side and RS-232 side
- Support user-defined end of characters on pair connection mode
- Support time stamp response on RS-232 side



### ■ Introduction

ICP DAS has provided a lot of UART/CAN product solutions which are widely recommended in the market. These UART/CAN converters can help users to implement the communication between RS-232 and CAN network. In order to cater for costing requirement, we provide a new solution of RS-232/CAN converter-tM-7530. The tM-7530 is a tiny RS-232/CAN to fit narrower environment as a result of its small size. It has isolation on power side and on CAN bus side and its performance is faster than other RS-232/CAN module. The function of tM-7530 can full compatibly with I-7530 and I-7530T. Besides, it provides new function such as listen only. User can use this function to listen CAN bus messages and error detection. According to above features, tM-7530 is an economical and practical RS-232/CAN converter solution.

### ■ Software Utility Features

- CAN Messages logger functions.
- Support group send CAN messages.
- Presents the CAN Bus loading by the trend via utility.
- Supports the configuration of the trigger event for starting transmission, stop reception or recording the messages.
- Integrate all CAN bus converter utility of ICP DAS.

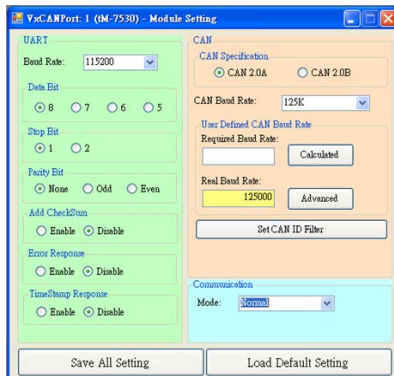
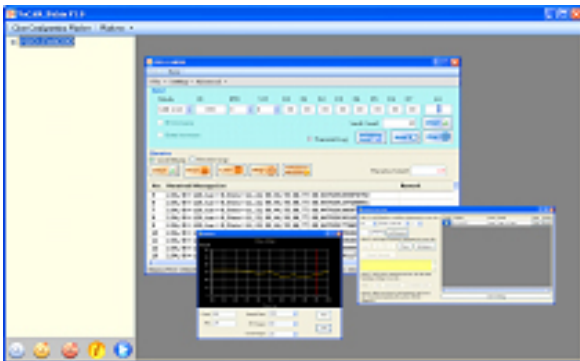

### ■ Wiring Connection

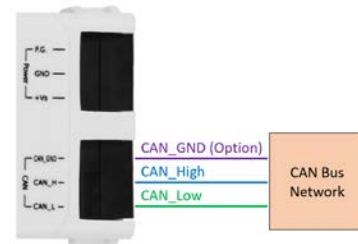

### ■ Pin Assignments

Pin	3-wire RS-232
1	N/A
2	TXD
3	RXD
4	N/A
5	GND
6	N/A
7	N/A
8	N/A
9	N/A

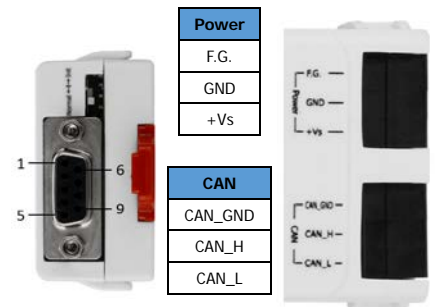

### ■ Dimensions (Units: mm)

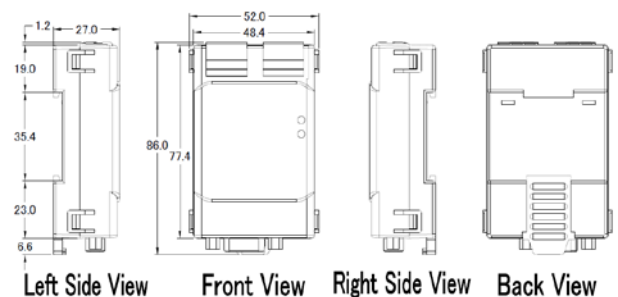

## Application

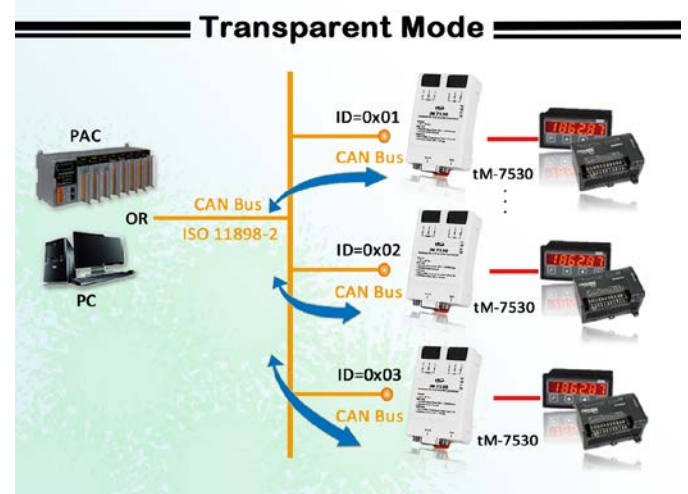
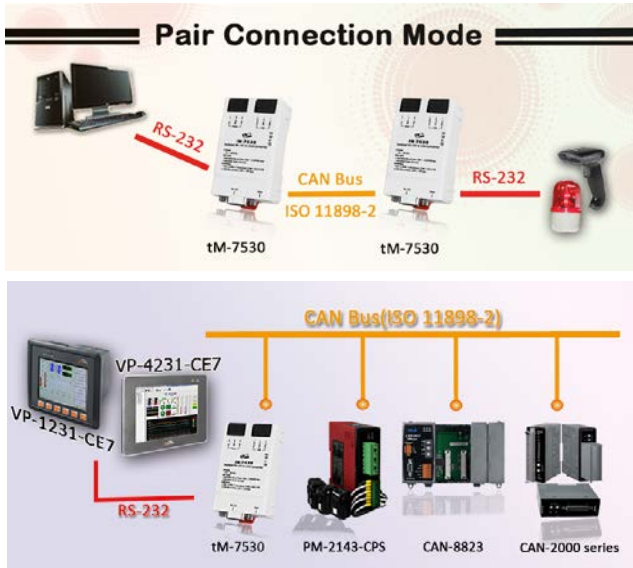

## Hardware Specifications

CAN Interface	
Controller	Microprocessor inside with 48MHz
Channel number	1
Connector	3-Pin Push-in type terminal block(CAN_GND, CAN_L, CAN_GND)
Baud Rate (bps)	10 k, 20k 50k, 100k, 125k, 250k, 500k, 800k, 1000k bps
Transmission Distance(m)	Depend on baud rate (for example, max. 1000 m at 50 kbps )
Isolation	3000VDC for DC-to-DC, 2500Vrms for photo couple
Terminal Resistor	External option the 120 Ω terminal resistor
Specification	ISO 11898-2, CAN 2.0A and CAN 2.0B
UART Interface	
COM	RS-232
COM Connector	9-pin female D-Sub (TxD, RxD, GND, N/A for others )
Baud Rate (bps)	110, 150, 300, 600, 1200, 2400, 4800, 9600, 19200, 38400, 57600, 115200, 230400 bps
Data Bit	5, 6, 7, 8
Stop bit	1, 2
Parity	None, Even, Odd
LED	
Round LED	Run LED: Power and Data Flow; ERR LED: Error
Power	
Protection	Power reverse polarity protection, Over-voltage brown-out protection
Input Range	+10 ~ +30 V <sub>DC</sub>
Power Consumption	1W
Mechanism	
Dimensions	56 mm x 86 mm x 32 mm (W x L x H)
Environment	
Operating Temp.	-25 ~ 75 °C
Storage Temp.	-30 ~ 80 °C
Humidity	10 ~ 90% RH, non-condensing

## Ordering Information

<b>tM-7530 CR</b>	Intelligent tiny RS-232 to CAN converter (RoHS)
-------------------	---